

SILO FOCUS - MODEL: TL15FLM

W Track Luminaires

WAC LIGHTING

Responsible Lighting®

Project Name:

Type:

Product Image



Line Drawing

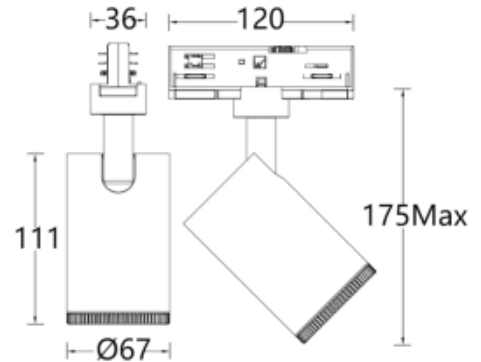

Product Description

SILO Focus Series LED Track Lights are suitable for W 3-circuit track system. The design is exquisite, made of die-cast aluminum. Built-in non-strobe driver, COB light module, adjustable light angle continuously. Widely used in museums, art galleries, commercial spaces, hotels, retail and other places to provide accent lighting or ambient lighting.

Product Features

- **Body Material:** Aluminum alloy die-casting lamp body
- **Optical System:** Adjustable Focusing Lens
- **Finish:** Electrostatic Powder Coating, Black (BK), White (WT)
- **Adjustable Angle:** Horizontal 0°~355° adjustment; Vertical 0~90° adjustment
- **Accessory:** Add up to three optical accessories, up to one of each type at the same time
- **Certification:** CCC
- **IP Rating:** IP20
- **Insulation Class:** Class I
- **Operating Temperature:** -20°C~40°C

Product Specifications

- **LED Type:** COB
- **Power:** 6W or 12W Optional
- **Source Lm:** 2700K: 610lm (6W) / 1090lm (12W)
3000K: 670lm (6W) / 1200lm (12W)
4000K: 720lm (6W) / 1290lm (12W)
5000K: 770lm (6W) / 1380lm (12W)
- **LED Lifetime:** >50000h-L70 / B10-Ta25°C(LM-80/TM-21)•
- **CCT/CRI:** 2700K / 3000K / 4000K / 5000K , >Ra90
- **SDCM:** 3 SDCM
- **Input:** 220V~240V AC / 50Hz
- **Dimming:** Built-in knob dimming (dimming range 10% ~100%), 1- 10V dimming (must do matching test with project site in advance)
- **Net Weight:** Approx. 0.5Kg, excluding packaging

Order Model

Model	LED	Dimming	Beam	CRI	CCT	Finish
TL15F SILO Focus	LM06 COB 6W	O On-board	F 12~50°	9 90	27 2700K	WT White BK Black
	LM12 COB 12W	D 0-10V			30 3000K	
					40 4000K	
					50 5000K	
TL15F	LM12	O	F	9	30	WT

Example: TL15FLM12-O-F930WT

WAC Lighting
www.waclighting.com (US)
www.waclighting.com.cn (China)

Headquarters
44 Harbor Park Drive • Port Washington, NY
Phone (516) 515.5000 • Fax (516) 515.5050

WAC Lighting(Shanghai)
14,Lane 299, Bi Sheng Road,Shanghai 201204
Phone (86.21) 3393.3558 • Fax (86.21) 3362.1598

SILO FOCUS - MODEL: TL15FLM

W Track Luminaires







WAC LIGHTING

Responsible Lighting®

Project Name:

Type:

Accessory

Accessory I	LENS-16-BEL-C Striped Glass Lens 	Soft Glass Lens LENS-16-BSL-SW 	Frosted Glass Lens LENS-16-FR 	Honeycomb Grid LENS-16-HCL 
Accessory II	Anti-glare Tube LENS-15-SNOOT 			
Accessory III	Four-leaf shades TL-21-BD-SW 			

Note: Up to three optical accessories can be added, with a maximum of one of each type at the same time.

Light Curve Distribution @3000K Data

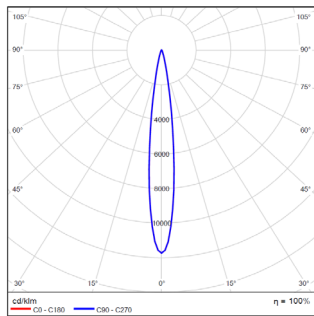

MODEL: TL15FLM06-O-F930
BEAM ANGLE: 12°
POWER: 8W
LUMENS: 183lm
CBCP: 2395cd
EFFICACY: 23lm/W

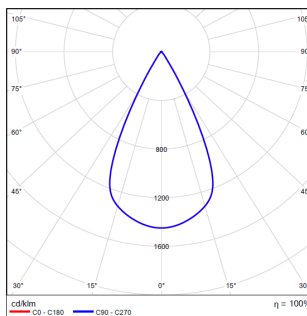

MODEL: TL15FLM06-O-F930
BEAM ANGLE: 50°
POWER: 8W
LUMENS: 291lm
CBCP: 424cd
EFFICACY: 36lm/W

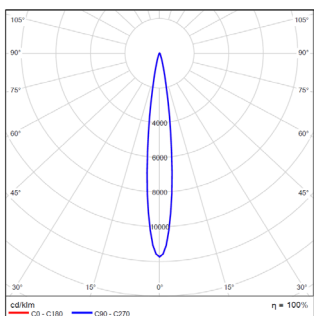

MODEL: TL15FLM12-O-F930
BEAM ANGLE: 12°
POWER: 14W
LUMENS: 272lm
CBCP: 3187cd
EFFICACY: 19lm/W

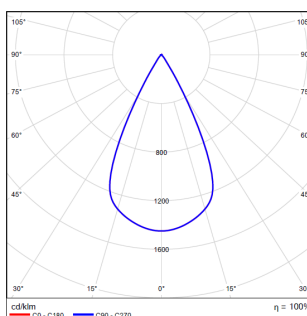

MODEL: TL15FLM12-O-F930
BEAM ANGLE: 50°
POWER: 14W
LUMENS: 425lm
CBCP: 616cd
EFFICACY: 30lm/W

SILO FOCUS - MODEL: TL16FLM

W Track Luminaires

WAC LIGHTING

Responsible Lighting®

Project Name:

Type:

Product Image



Line Drawing

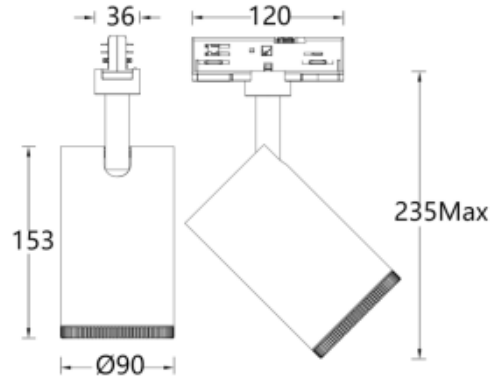

Product Description

SILO Focus Series LED Track Lights are suitable for W 3-circuit track system. The design is exquisite, made of die-cast aluminum. Built-in non-strobe driver, COB light module, adjustable light angle continuously. Widely used in museums, art galleries, commercial spaces, hotels, retail and other places to provide accent lighting or ambient lighting.

Product Features

- **Body Material:** Aluminum alloy die-casting lamp body
- **Optical System:** Adjustable Focusing Lens
- **Finish:** Electrostatic Powder Coating, Black (BK), White (WT)
- **Adjustable Angle:** Horizontal 0°~355° adjustment; Vertical 0~90° adjustment
- **Accessory:** Add up to three optical accessories, up to one of each type at the same time
- **Certification:** CCC
- **IP Rating:** IP20
- **Insulation Class:** Class I
- **Operating Temperature:** -20°C~40°C

Product Specifications

- **LED Type:** COB
- **Power:** 18W or 26W optional
- **Source Lm:** 2700K: 1550lm (18W) / 2270lm (26W)
3000K: 1700lm (18W) / 2500lm (26W)
4000K: 1820lm (18W) / 2670lm (26W)
5000K: 1950lm (18W) / 2870lm (26W)
- **LED Lifetime:** >50000h-L70 / B10-Ta25°C(LM-80/TM-21)
- **CCT/CRI:** 2700K / 3000K / 4000K / 5000K , >Ra90
- **SDCM:** 3 SDCM
- **Input:** 220V~240V AC / 50Hz
- **Dimming:** Built-in knob dimming (dimming range 10%~100%), DALI, 1-10V dimming (must be done in advance with the project site to match the test)
- **Net Weight:** Approx. 1.0Kg, excluding packaging

Order Model

Model	LED	Dimming	Beam	CRI	CCT	Finish
TL16F SILO Focus	LM18 COB 18W	O On-board	F 12~50°	9 90	27 2700K	WT White
	LM26 COB 26W	A DALI			30 3000K	
		D 0-10V			40 4000K	BK Black
					50 5000K	
TL16F	LM18	O	F	9	30	WT

Example: TL16FLM18-O-F930WT

WAC Lighting
www.waclighting.com (US)
www.waclighting.com.cn (China)

Headquarters
44 Harbor Park Drive • Port Washington, NY
Phone (516) 515.5000 • Fax (516) 515.5050

WAC Lighting(Shanghai)
14,Lane 299, Bi Sheng Road,Shanghai 201204
Phone (86.21) 3393.3558 • Fax (86.21) 3362.1598

SILO FOCUS - MODEL: TL16FLM

W Track Luminaires







WAC LIGHTING

Responsible Lighting®

Project Name:

Type:

Accessory

Accessory I	Striped Glass Lens LENS-73-BEL-C 	Soft Glass Lens LENS-73-BSL 	Frosted Glass Lens LENS-73-FR 	Honeycomb Grid LENS-73-HCL-C 
Accessory II	Anti-glare Tube LENS-20-SNOOT 		Anti-glare Honeycomb LENS-20-HCL 	
Accessory III	Four-leaf Shades LENS-73-BD 			

Note: Up to three optical accessories can be added, with a maximum of one of each type at the same time.

Light Curve Distribution @3000K Data

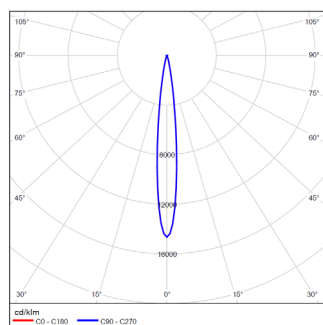

MODEL: TL16FLM18-O-F930
BEAM ANGLE: 12°
POWER: 21W
LUMENS: 319lm
CBCP: 4670cd
EFFICACY: 15lm/W

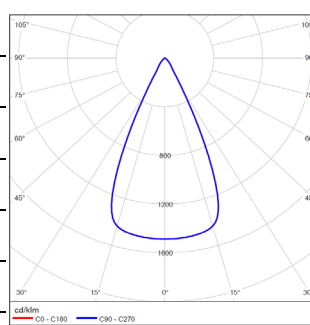

MODEL: TL16FLM18-O-F930
BEAM ANGLE: 50°
POWER: 21W
LUMENS: 463lm
CBCP: 689cd
EFFICACY: 22lm/W

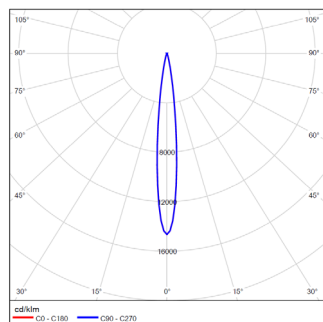

MODEL: TL16FLM26-O-F930
BEAM ANGLE: 12°
POWER: 30W
LUMENS: 439lm
CBCP: 5859cd
EFFICACY: 15lm/W

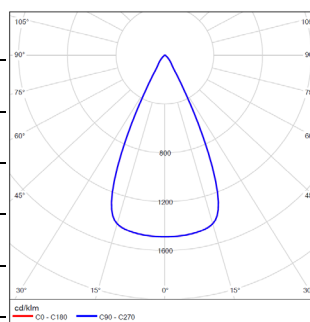

MODEL: TL16FLM26-O-F930
BEAM ANGLE: 50°
POWER: 30W
LUMENS: 639lm
CBCP: 952cd
EFFICACY: 21lm/W

SILO FOCUS - MODEL: TL17FLM

W Track Luminaires

WAC LIGHTING

Responsible Lighting®

Project Name:

Type:

Product Image



Line Drawing

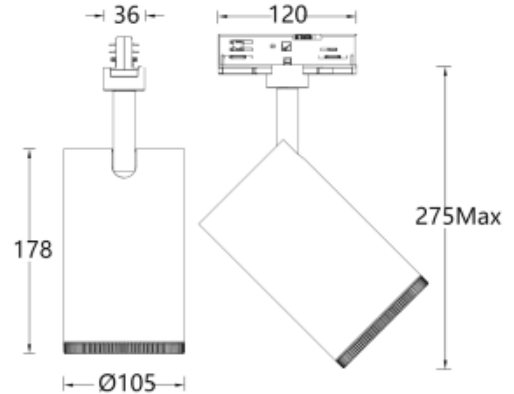

Product Description

SILO Focus Series LED Track Lights are suitable for W 3-circuit track system. The design is exquisite, made of die-cast aluminum. Built-in non-strobe driver, COB light module, adjustable light angle continuously. Widely used in museums, art galleries, commercial spaces, hotels, retail and other places to provide accent lighting or ambient lighting.

Product Features

- **Body Material:** Aluminum alloy die-casting lamp body
- **Optical System:** Adjustable Focusing Lens
- **Finish:** Electrostatic Powder Coating, Black (BK), White (WT)
- **Adjustable Angle:** Horizontal 0°~355° adjustment; Vertical 0~90° adjustment
- **Accessory:** Add up to three optical accessories, up to one of each type at the same time
- **Certification:** CCC
- **IP Rating:** IP20
- **Insulation Class:** Class I
- **Operating Temperature:** -20°C~40°C

Product Specifications

- **LED Type:** COB
- **Power:** 34W
- **Source Lm:** 3280lm (2700K) / 3600lm (3000K)
3880lm (4000K) / 4140lm (5000K)
- **LED Lifetime:** >50000h-L70 / B10-Ta25°C(LM-80/TM-21)
- **CCT/CRI:** 2700K / 3000K / 4000K / 5000K , >Ra90
- **SDCM:** 3 SDCM
- **Input:** 220V~240V AC / 50Hz
- **Dimming:** Built-in knob dimming (dimming range 10%~100%), DALI, 1 - 10V dimming (must be done in advance with the project site to match the test)
- **Net Weight:** Approx. 1.4Kg, excluding packaging

Order Model

Model	LED	Dimming	Beam	CRI	CCT	Finish
TL17F SILO Focus	LM34 COB 34W	O On-board A DALI D 0-10V	F 12~50°	9 90	27 2700K 30 3000K 40 4000K 50 5000K	WT White BK Black
TL17F	LM34	O	F	9	30	WT

Example: TL17FLM34-O-F930WT

WAC Lighting

www.waclighting.com (US)

www.waclighting.com.cn (China)

Headquarters

44 Harbor Park Drive • Port Washington, NY

Phone (516) 515.5000 • Fax (516) 515.5050

WAC Lighting(Shanghai)

14,Lane 299, Bi Sheng Road,Shanghai 201204

Phone (86.21) 3393.3558 • Fax (86.21) 3362.1598

SILO FOCUS - MODEL: TL17FLM

W Track Luminaires







WAC LIGHTING

Responsible Lighting®

Project Name:

Type:

Accessory

Accessory I	Striped Glass Lens LENS-73-BEL-C 	Soft Glass Lens LENS-73-BSL 	Frosted Glass Lens LENS-73-FR 	Honeycomb Grid LENS-73-HCL-C 
Accessory II	Anti-glare Tube LENS-20-SNOOT 		Anti-glare Honeycomb LENS-20-HCL 	
Accessory III	Four-leaf Shades TL-22-BD-SW 			

Note: Up to three optical accessories can be added, with a maximum of one of each type at the same time.

Light Curve Distribution @3000K Data

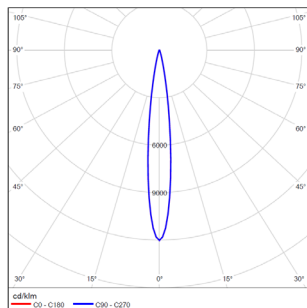

MODEL: TL17FLM34-O-F930
BEAM ANGLE: 12°
POWER: 38W
LUMENS: 564lm
CBCP: 6780cd
EFFICACY: 15lm/W

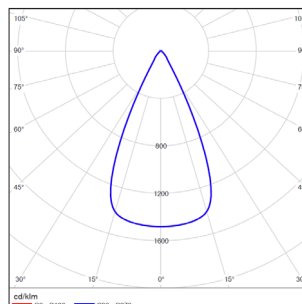

MODEL: TL17FLM34-O-F930
BEAM ANGLE: 50°
POWER: 38W
LUMENS: 813lm
CBCP: 1205cd
EFFICACY: 21lm/W